

CARB toroidal roller bearings, cylindrical and tapered bore

Principal dimensions			Basic load ratings		Speed ratings		Designation	
d	D	B	dynamic C	static C0	Reference speed	Limiting speed	* SKF Explorer bearing	** Check availability
mm			kN		r/min		-	
75	105	40	204	325	-	1900	C 5915 V *	-

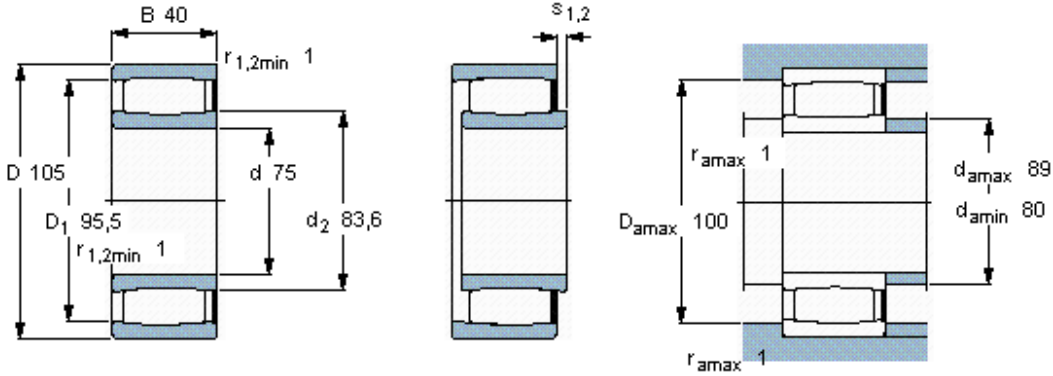

Axial displacement s_1	9,4	
Axial displacement s_2 (retaining ring side)	6,2	
Misalignment factor k_1	0,098	
Operating clearance factor k_2	0,114	